



# Instruction Manual

## 1U Vented Cantilever Shelf

### Save These Instructions

This manual contains instructions and warnings that must be followed during the installation and operation of the product described in this manual. Failure to comply may invalidate the warranty and cause property damage or personal injury.

Thank you for purchasing a Tecmojo product. Please check the product carefully and contact Tecmojo for assistance if any parts are damaged or missing. Do not attempt to install or use product if it has been damaged. This product contains small items that could be a choking hazard – keep these items away from children.

For permanent wall mounting, be sure to securely fasten the enclosure to the building structure before operation.

Do not use with equipment that is heavier than the indicated weight capacity for this product. This product is designed to be installed indoors on wood stud walls, solid concrete walls or brick walls. Make sure that the supporting surface will safely support the weight of the equipment and all attached hardware and components. It is recommended that installation be performed by a qualified installer. Tecmojo cannot be held responsible for damage to equipment or personal injury resulting from improper use or installation of product.

Maintenance: we recommend checking on regular basis that the product is secure and safe to use.



Limitations of Liability: In no event will Tecmojo Co. be liable for any damages, whether direct or indirect, special, punitive, incidental or consequential damages (including, but not limited to, lost profits or revenue, loss of use, lost business opportunities or loss of goodwill) or for the costs of procuring substitute products, arising out of or in connection with the use of the product, whether such liability arises from any claim based upon contract, warranty, tort (including negligence), product liability or otherwise, whether or not seller has been advised of the possibility of such loss or damage. In no event will seller's total cumulative liability, from all causes of action and all theories of liability, exceed the total amounts actually paid to seller by customer under the order that gives rise to any liability hereunder.

### Specification:

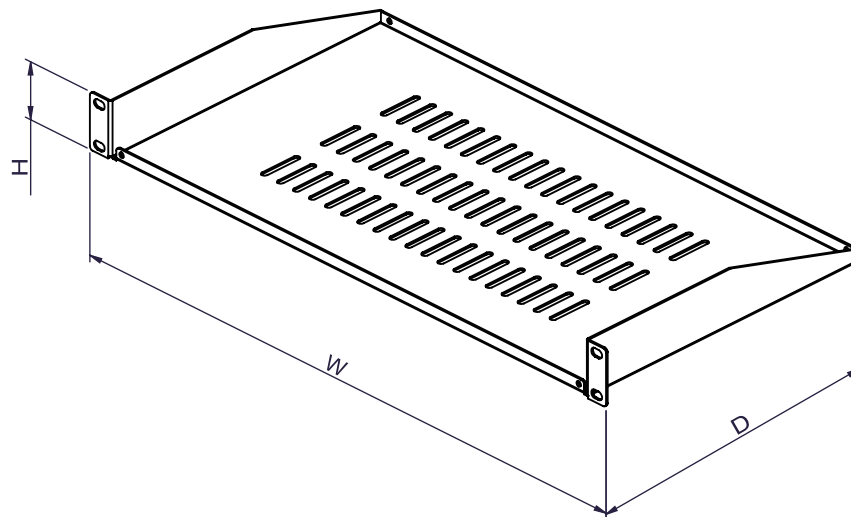
SKU#	Capacity ( U )	Width ( mm )	Depth ( mm )	Height ( mm )
14110101	1U	482.6	152.4	44
14110102	1U		203.2	
14110103	1U		254	
14110104	1U		279.4	
14110105	1U		355.6	

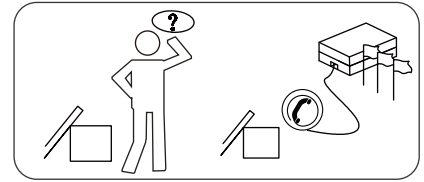
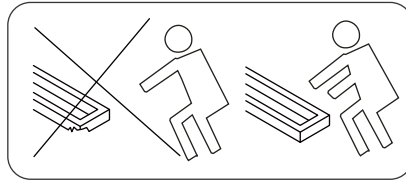
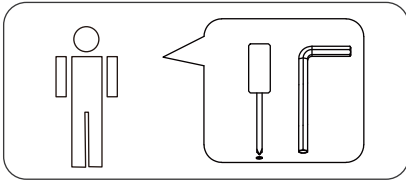



SKU#	Qty	ITEM	M6*12 Screws	M6 Plastic Gasket	M6 Cage Nut
		ITEM			
	14110101		4	4	4
	14110102		4	4	4
	14110103		4	4	4
	14110104		4	4	4
	14110105		4	4	4

